

HANDLE SET INSTALLATION-W&F ENTRY HARDWARE™ ENTRANCE GRIP

Overview

Check contents and identify all parts before proceeding

PARTS INCLUDED FOR GRIP HANDSETS

- | | |
|-----------------------------|--|
| Interior Escutcheon: | (1) Individually Packed with Cartridge Installed |
| Exterior Escutcheon: | (1) Individually Packed
(1) Escutcheon Gasket |
| Toe Plate: | (1) Toe Plate
(1) #10-32 Grip Screw |
| Handle Pack: | (1) Lever Handle |
| Key Cylinder Pack: | (1) Key Cylinder with (2) Keys
(1) #8 x 3/8" Self Tapping Screw
(2) #10-32 Mounting Screws
(1) Standard Drive Spindle |
| Drive Spindle Pack: | (1) Drive Spindle for Grip Handle
(1) Supplementary Instructions |

Ø 1-11/16" OR Ø 2-1/8"
Crossbore Holes

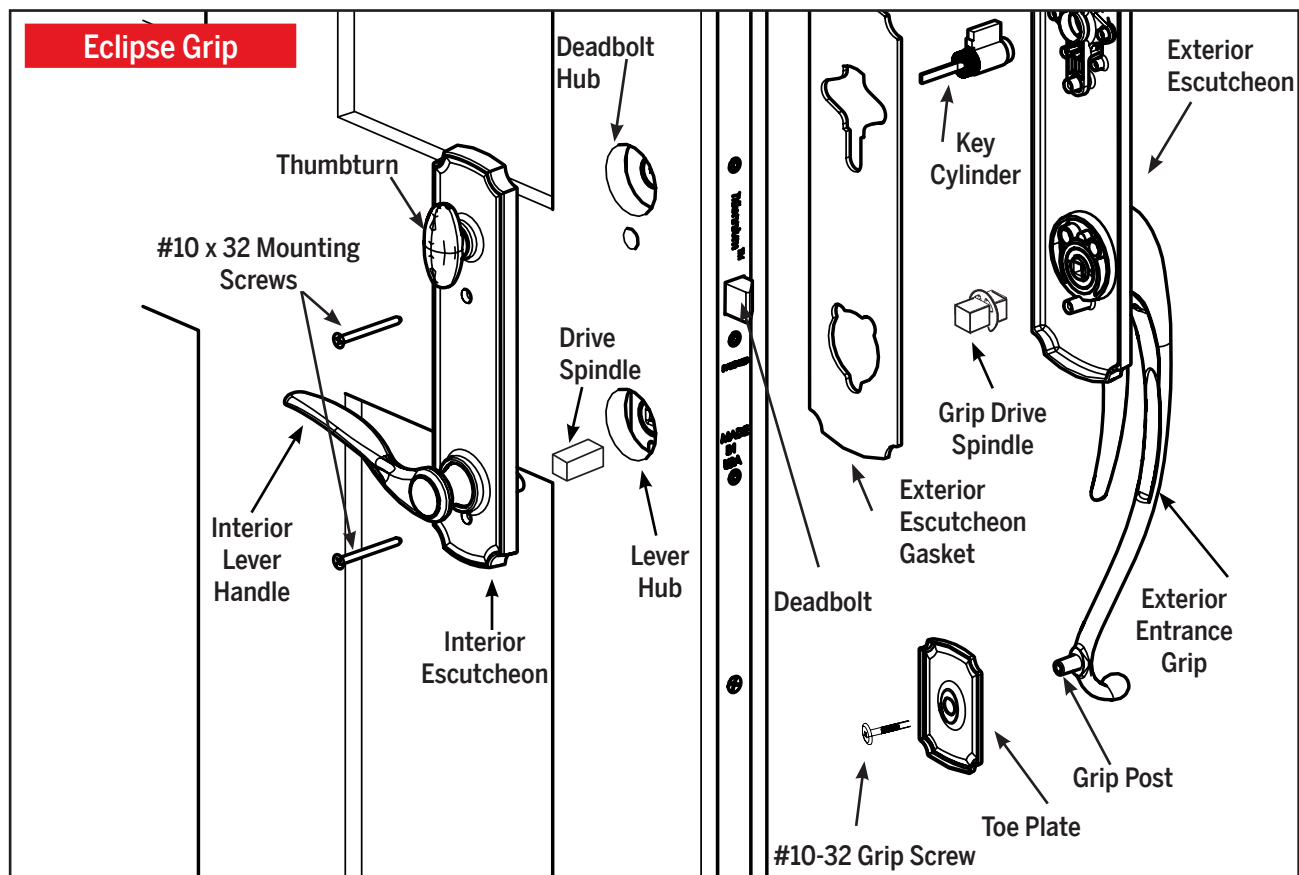

HANDLE SET INSTALLATION-W&F ENTRY HARDWARE™ ENTRANCE GRIP

1. PREPARE EXTERIOR ESCUTCHEON

- Remove key from lock cylinder.
- Insert lock cylinder into upper hole from back side of escutcheon plate with tab pointing up. Orient as shown
- Secure lock cylinder with # 8 x 3/8" self-tapping screw.

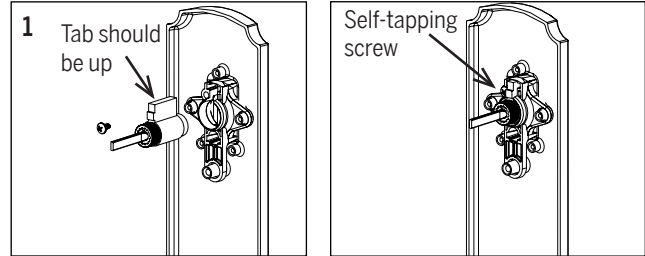

2. ATTACH THE LEVER TO THE INTERIOR ESCUTCHEON

- Insert the handle into square recess in spindle and hold in place.
- Insert the handle mounting screw into the center of the cartridge and hand tighten with the Allen Wrench provided.
- Pull the lever tight against the cartridge to ensure that it is fully tightened.

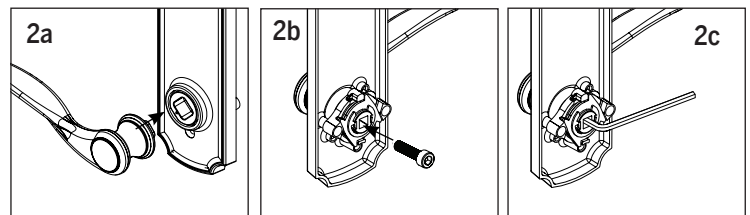

3. CHECK HARDWARE IN DOOR FOR ALIGNMENT OF HUB

- Open door by turning the inside lever hub of the lock
- Deadbolt slot must be vertical
- Bolts must be in the latched (not deadbolted) position

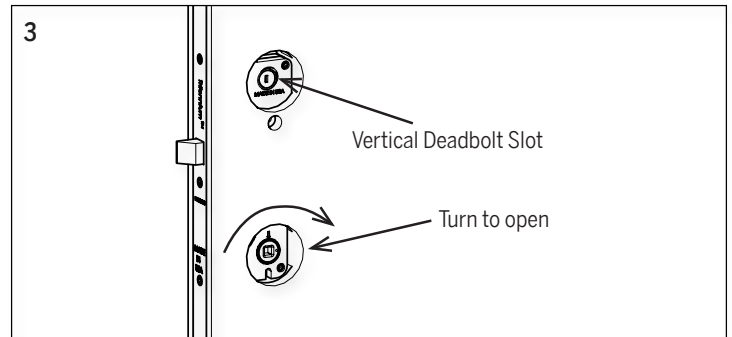

4. INSERT THE DRIVE SPINDLES

- Insert the short end of the drive spindle into the exterior grip assembly.
- Insert the other drive spindle into the interior escutcheon cartridge.

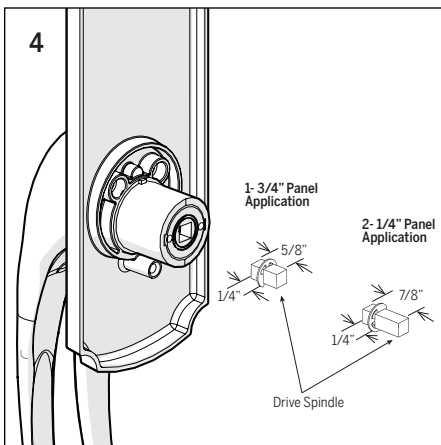

5. POSITION ESCUTCHEONS TO DOOR PANEL

- Exterior first:** Place Escutcheon Gasket over inside face of escutcheon. Guide Key Cylinder Tailpiece and Spindle into respective hubs in hardware, and guide the bottom grip post through the toe plate. Reference diagram on page 1
- Hold in place
- Interior next:** Make certain that receiving slot in thumbturn lines up with the Key Cylinder Tailpiece.
- Secure with (2) #10-32 Mounting Screws from interior to exterior. Hand-tighten snug. **DO NOT OVERTIGHTEN**
- Secure the toe plate between the grip handle and the door panel with the #10-32 Grip Screw

HANDLE SET INSTALLATION-W&F ENTRY HARDWARE™ ENTRANCE GRIP

7. STRIKE PLATE ASSEMBLY (IF NOT ALREADY COMPLETE)

Parts Required

- (3) Dust Boxes
- (3) Reinforcing Plates
- (3) Strike Plates
- (6) 3/4" screws
- (3) #10 x 2-1/2" screws

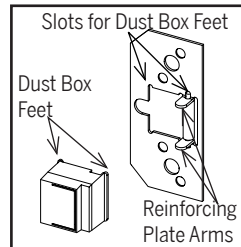

- The Dust Box Feet should align with the slots in the reinforcing plate.
- The reinforcing plate arms should sit inside the dust box.

Attach strike plates to jamb.

- Attach the Dust Box to the Reinforcing Plate.
- Align the 3 holes on the Strike Plate with the Reinforcing Plate.
- Orient as shown.
- Use 3/4" screws in top and bottom holes of each strike.
- Use long #10 x 2-1/2" Screw in center hole.
- Repeat for remaining strike locations.

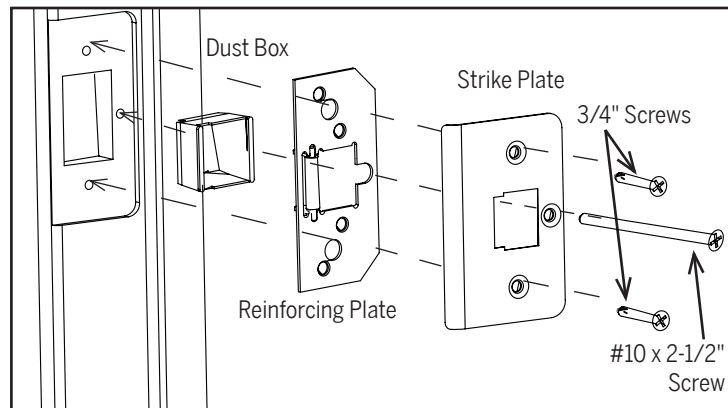

Note

A $\varnothing 1/8$ " pilot hole should be drilled into the rough framing for the long screw.

Note

Solid shimming should be placed behind the jamb at each strike location to allow for firm anchoring to structure.

8. FINAL OPERATION CHECK

- All three latch bolts should engage strikes as door is closed.
- Turn thumbturn 90° to extend all three bolts an additional 1/2" to deadbolted position.
- Rotate interior lever downward to disengage bolts and open door. Bolts can also be moved to latched position by turning thumbturn.
- Engage deadbolt again. From the exterior, confirm that the lever cannot rotate and disengage the latches (door is deadbolted). Confirm that the door can be unlocked with the key and then opened by rotating the lever downward.

Innovation protected under patents and patents pending in U.S. and Canada. See www.EnduraPatents.com.

The information contained in this document is the confidential and proprietary information and trade secrets of Endura Products, Inc. Any disclosure, use or dissemination of such information without the express written permission of Endura Products, Inc. is strictly prohibited. Endura Products, Inc. also owns any and all intellectual property rights embodied in such information, including patent rights, copyrights, and trademark rights, and no license of any intellectual property right is intended, nor should any license be implied, as a result of the receipt of this document.

Rev. 10.05.2018