

# ENDURA PRODUCTS DOOR SYSTEM OWNERS MANUAL



Thank you for your purchase of door system components from Endura Products, Inc.

Endura's components are designed to create performance and lasting value for your door system.

This manual will assist you with the care and maintenance of door systems with Endura components.

For additional information, visit [www.enduraproducts.com](http://www.enduraproducts.com)



1.800.334.2006  
[www.enduraproducts.com](http://www.enduraproducts.com)

**Performance Endura Components:** Endura Products, Inc. designs, test and develops the highest performance exterior door components on the market. Please utilize this guide, in addition to instructions for door panel finishing and maintenance, for ongoing performance of your door system.

## Endura Components Include:

- Z Series Composite Inswing or Bumper Outswing Sill
- Q-Lon® Weatherstrip
- Simple Solution™ Corner Pad
- Door Bottom Seal
- Ultimate Astragal (French Door Units)
- Multi-Point Astragal (French Door Units)
- Continuous Sill and Header, One Piece Mulls for Sidelite and Hinged Patio Door Units
- Endura Sill Pan
- Endura or other approved Multi-Point Locking System
- FrameSaver Door Frames, Mullions, Brick Mould

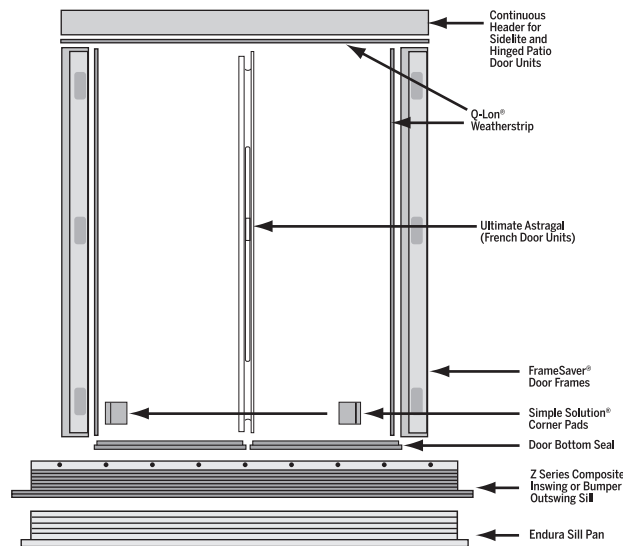

Form# GOwn-17 Rev 6.17

**Door Unit Care and Maintenance:** Your Door Unit with Endura components was designed to provide the maximum possible performance against air and water infiltration for the door panel and configuration selected. For continued performance over an extended period of time the following instructions should be followed:

**Caulking and Resealing:** Recaulking is required to maintain integrity of joints. At least one (1) time per year, inspect and recaulk the following with high quality exterior-grade caulk if caulk has split or is missing:

- Joints at the brickmould, frames, headers or mulls;
- Joints between the sill deck and frames and mullions;
- Joints between the sill caps (active and inactive caps) and frame;
- Joints between the exterior sill and subsurface

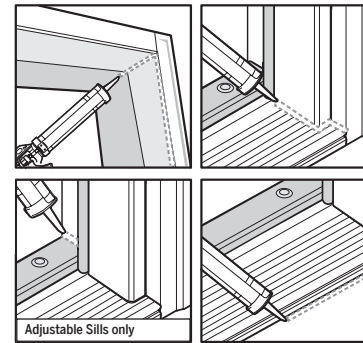

**Door Sill Adjustment:** Z-Series Sills from Endura are patented and proven to be the best and most durable sill on the market. The following steps should be taken at least one (1) time per year to ensure proper sealing and prevention of air and water infiltration:

- As the house or door unit settles, contact between the sill and door bottom may become uneven. Adjust sill cap (inswing sills) to meet door bottom as follows:
  - Remove Simple Solution™ Corner Pads;
  - Remove the cap plugs on top of sill cap;
  - Adjust the screws counter-clockwise to meet the desired cap height;
  - Replace the cap plugs;
  - Replace Simple Solution Corner Pads (Caulk where cap meets jamb first)

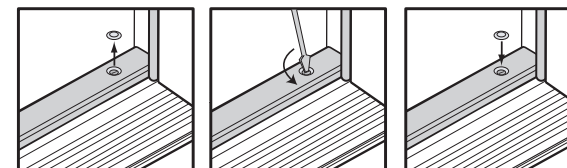

- In the case of a humped sill where adjustment of the cap will not resolve contact issues, further steps may be taken as follows:

- Remove door from hinges and opening;
- Remove brick mould or casing;
- Remove hinge long screws anchoring door to rough opening;
- Shim jamb legs up to allow sill to straighten;
- Replace long screws, door, brick mould;
- Recaulk all joints

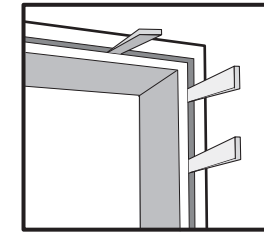

- Check sill cap length: In cases of extreme exposure, the sill cap may not, over time, meet the overall length of the opening. Contact your distributor or dealer for a replacement cap. Replace as follows:

- Remove existing corner pads;
- Remove existing cap: Using a standard slotted screwdriver, insert end of screwdriver under front (exterior) lip of cap at one end and pry upwards. Repeat step at middle and other end of cap until cap is lifted off. Remember to protect the deck of the sill with a soft cloth to prevent scratching;
- Cut replacement cap to length of opening;
- Position cap over cap channel and, using moderate pressure, push cap down into channel;
- Adjust cap to meet door bottom uniformly;
- Reapply Simple Solution™ Corner Pads (Caulk where cap meets jamb first)

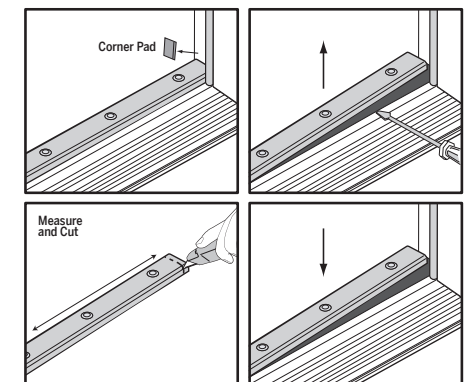

**Door Bottom Wear and Replacement:** Over time and operation of the door unit, door bottoms may tear, bunch or lose elasticity and memory. Door Bottoms must be checked one (1) time per year and replaced if necessary. Replacement door bottoms can be obtained from your Distributor and replaced as follows:

- Remove door from hinges and opening;
- Remove old door bottom: Insert slotted screwdriver at one end of door bottom and remove along length of door; Clean and remove any remaining staples and caulk from bottom of door and kerf slots in door;
- Cut replacement door bottom to length of door panel;
- Apply the caulk at each end of the door bottom and along the base of the exterior kerf leg (**Adjustable Sills Only**)
- Press replacement door bottom in place – staple to secure;
- Allow caulk to dry then reinstall door in opening.

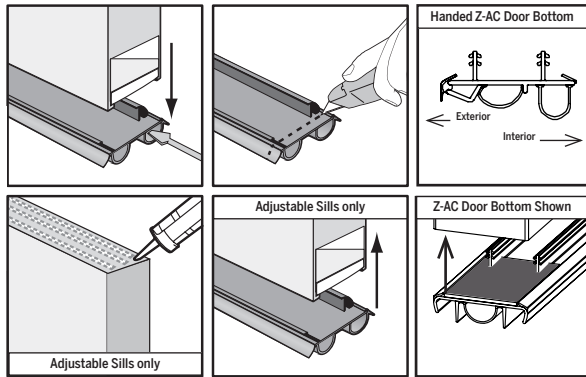

### Weatherstrip Positioning, Wear and Replacement:

Weatherstrip may be improperly installed or become torn or damaged. Check Weatherstrip upon installation and one (1) time a year for (i) tears in Weatherstrip; (ii) Weatherstrip not to length; (iii) Weatherstrip not meeting at intersection of frames and headers; or (iv) Weatherstrip bunched at bottom against door sill. Any of the above require repositioning or replacement of the weatherstrip as follows:

- Measure length of side frame/mull weatherstrip kerf from top of frame slot to sill deck – cut weatherstrip to indicated length and install in kerf. Take care to avoid bunching along length of kerf or at ends;
- Measure length of header kerf – cut weatherstrip to indicated length and install in kerf. Header weatherstrip must meet side jambs evenly at both sides.
- **DO NOT PAINT WEATHERSTRIP.** Paints, stains or varnishes contain solvents which, when coming into contact with materials used in weatherstripping, cause these materials to lose their flexible qualities, making them brittle and leading to a loss of sealing contact.

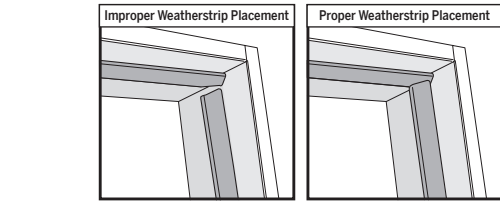

### Simple Solution™ Corner Pad Positioning, Wear and Replacement:

Corner Pads are an integral part of the door system weathersealing. Damaged or incorrectly positioned corner pads can cause a loss of sealing. Check corner pads upon door installation and at least one (1) time a year for the following:

- Corner Pads should be applied **ONLY AFTER** (i) final painting; and (ii) sill cap adjustment. If door frame is repainted, Corner Pads should be removed and a new pair reapplied;
- After final sill cap adjustment (or upon replacement), position Simple Solution pad as follows:
  - Place bead of caulking at end of sill cap (Adjustable Sills only)
  - Remove the adhesive backing pad
  - The fin of the corner pad should be tucked under the weatherstrip, and aligned flush with the interior face of the jamb
  - The bottom of the Simple Solution Pad should be flush with the cap of the sill for adjustable sills, or contacting the top of the Z-End Base™ for articulating sills;
  - Rotate Simple Solution Corner Pad in place

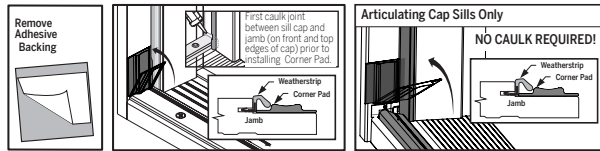

**Ultimate Astragal:** To ensure proper performance of the Ultimate Astragal, check the following upon installation and one (1) time per year:

- Ensure proper margin between active and inactive doors when active door is closed – margin should be 1/8" maximum
  - If margins exceed 1/8", remove casing, doors from hinges and long hinge screws into rough opening. Shim behind frames at hinge points on both active and inactive doors to gain proper margin.
  - Replace long screws, doors and casing. Recaulk where necessary.

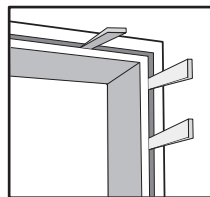
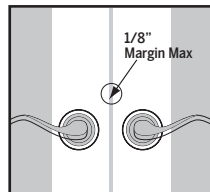

- Ensure header and sill flush bolt receivers are installed properly and flush bolt movement is for full range of operation;
    - Check that depth of holes for flush bolt receivers are drilled to proper depth – 1 - 3/8" for sill receiver, through header for upper flush bolt
    - Check that flush bolt receivers are installed and flush with sill cap and header surfaces
    - Check that flush bolts, when fully engaged, are in full contact with sill cap and header
  - Ensure proper compression of weatherstrip of astragal when active door is closed;
    - If compression is not tight or apparent, loosen screws on strike and deadbolt plates on astragal and reposition inward to draw active door in tighter. Retighten screws.
  - If door unit contains Endura's Wood Veneer Ultimate Astragal, exterior wood veneer should be finished with a stain and sealer or other finish appropriate for exterior applications. Finish must be applied to exterior wood surface initially prior to or during installation of door unit and should be checked one (1) time per year and refinished as necessary to prevent any deterioration of wood veneer.
- Exterior Frame/Hardware Adjustments:** Proper, tight and consistent contact between the door panel and the weatherstrip is critical for superior performance. Check the following upon installation and two (2) times per year:
- If door panel is sagging in the frame or margins are inconsistent:
    - Ensure that one long screw is properly installed in each hinge (two on the top hinge) through the frame into the rough opening
    - Ensure that frame and door are square. Check side frames, header and sill for level and measure diagonal distances from interior header corners to opposite jamb bottom. If not level or distances are not equal, loosen long hinge screws, remove door, remove interior casing (and exterior brick mould if necessary) and reshim to obtain level and square unit. Replace long screws, door and casing and caulk all joints thoroughly.

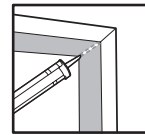
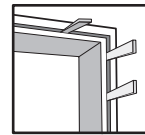
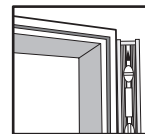
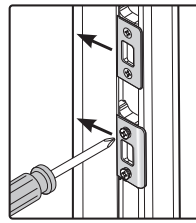
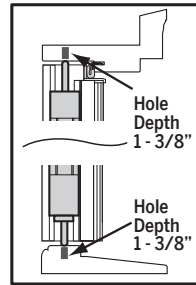

- If door panel is not meeting weatherstrip evenly or consistently when it closes:
  - Use a level to check that door is not warped. A warped door panel will need to be replaced by the dealer/distributor.
  - Check strike and deadbolt plate positioning; reposition towards the stop of the frame if required;
  - If door panel is not warped and repositioning of strike and deadbolt plates do not draw in door for full compression, check lock-side frame for alignment with panel. If frame is out of alignment, re-shim, readjust and re-nail frame so door meets the weatherstrip evenly from top to bottom.

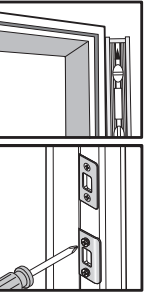

**Flashing/Weatherproofing:** Properly installed and maintained head flashing is required to protect the top surfaces of the door unit and prevent leaking around the door frame.

- Following installation, check to ensure that sheet metal or other impervious head flashing is installed to serve as a moisture barrier above the brick mould, that a water resistant tape or seal has been installed over the head flashing, and that caulk has been applied around all joints between flashing, brick mould and other surfaces
- Visually inspect header flashing one (1) time per year for any damage, cracks in joints or other gaps in the moisture barrier. Repair or replace flashing as necessary. Recaulk all joints.

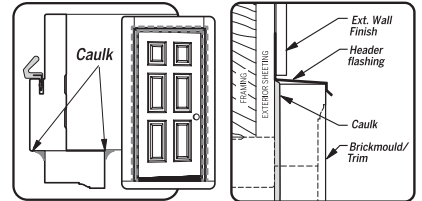

- **Exterior Frame Painting & Refinishing:** Repainting every 1 to 5 years will be required, depending upon weather exposure and the paint manufacturer's recommendations. Any signs of blistering, peeling or cracking the finish should be immediately repaired to protect the wood underneath. Failure to properly protect the frame with a top coat will result in wood damage, including finger joint damage.
  - Thoroughly dry surfaces, making them free of dust, dirt, oil, grease, wax, chalk and other contaminants.
  - A high quality exterior latex paint, preferably a 100% acrylic-based product, should be used as a finish coat.
  - Follow the paint manufacturer's recommendations on thinning, application techniques, re-coat and dry times.
  - In general, paint should be applied when both the surface and air temperature is between 50 and 90 degrees F. Relative humidity should be below 85%.