

# Ultimate Hurricane Astragal

## Inswing Field Installation Instructions



8817 West Market Street  
 Colfax, NC 27235 | 800.334.2006  
 www.enduraproducts.com

### Tools Required:

- Pencil/Marker
- Utility Knife
- Drill (3/8" and 5/8" Bits)
- Rubber Mallet

### Kit Includes:

- Hurricane Header Plate (1)
- #8 x 3" Screws (6)
- Lower Bolt Receiver (1)

**Before you begin:** Install corner pads on door hinge jambs to establish proper jamb side margins. This ensures accurate locations on header and sill for the bolt receivers.

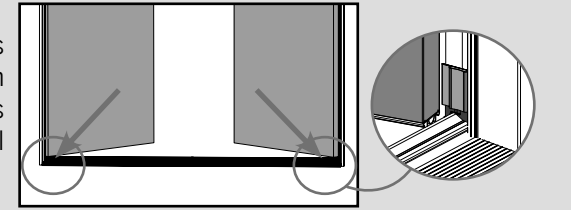

## STEP 1: INSTALL HEADER AND SILL BOLT RECEIVERS

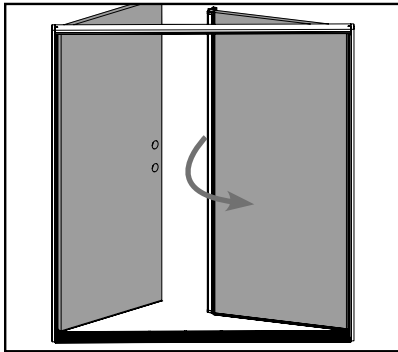

**a.** Close the inactive door panel until the weatherstrip on the header is compressed.

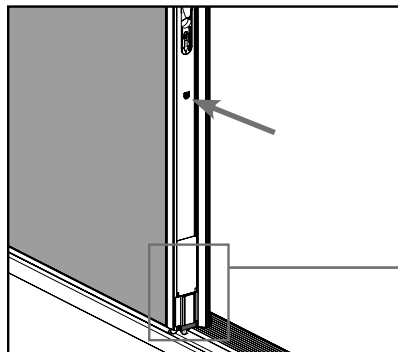

**b.** Press and engage the upper and lower bolts so the bolt pins come in contact with the header and the sill. Mark these points of contact.

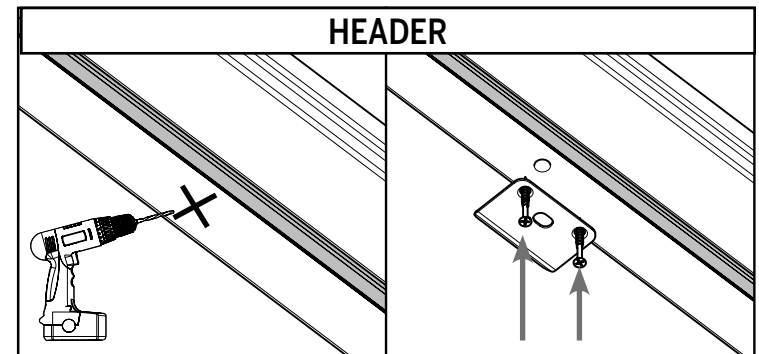
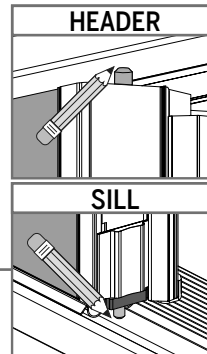

**c.** At the marked location on the header, drill a hole **3/8" in diameter** and at least **1-3/8" deep**. Install the header strike plate into the header, using two #8 x 3" screws.

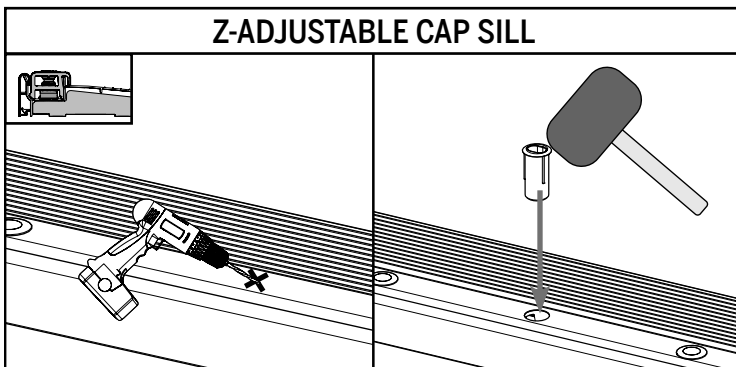

**d.** At the marked location on the sill, drill a hole **5/8" in diameter** and at least **1-3/8" deep**. Install the lower bolt receiver by tapping into the sill with a rubber mallet.

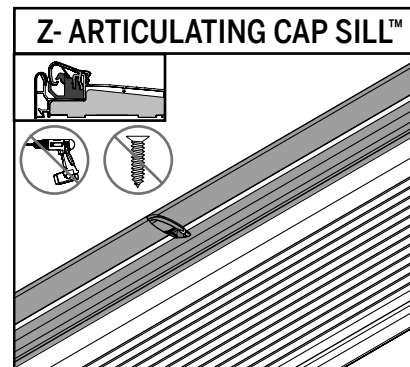

**NOTE:** If using a Z-AC sill, **no drilling is necessary** as the bolt receiver is pre-installed.

## STEP 2: INSTALL STRIKE AND DEADBOLT PLATES

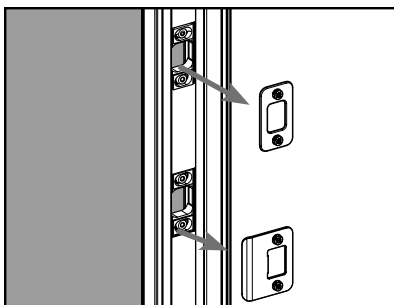

**a.** If installing new strike and deadbolt plates, remove the screws securing the old plates.

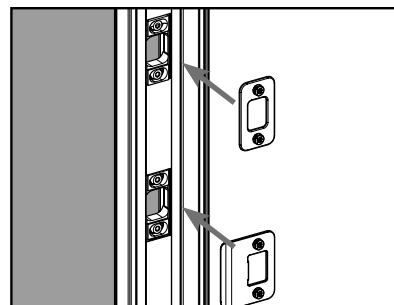

**b.** Install the new hardware into the retainers by tightening the screws through the holes in the plates.

## STEP 3: CUT WEATHERSTRIP AT HEADER

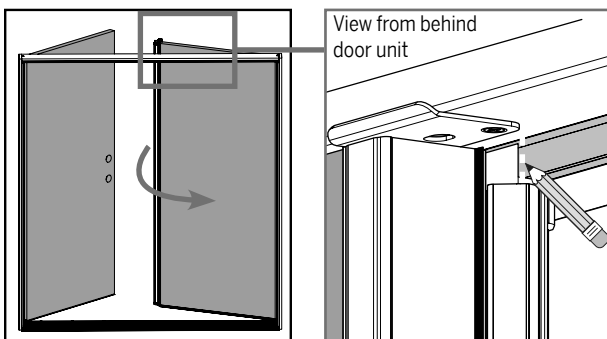

**a.** Close the inactive door. Make a mark at the location where the trim cap contacts the weatherstrip.

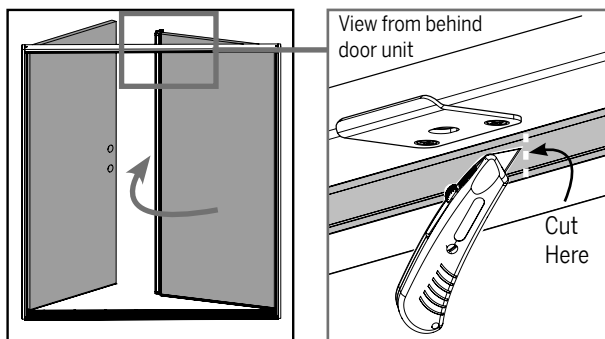

**b.** Open the inactive door. Using a utility knife, make a slit in the weatherstrip along the mark made.

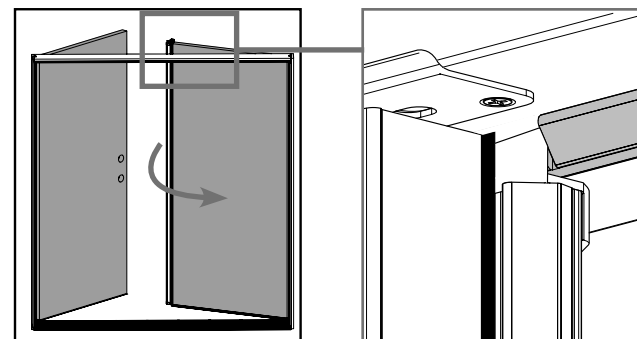

**c.** Close the inactive door panel. Ensure the weatherstrip forms a secure seal around the trim cap.

## STEP 4: CONFIRM PROPER INSTALLATION

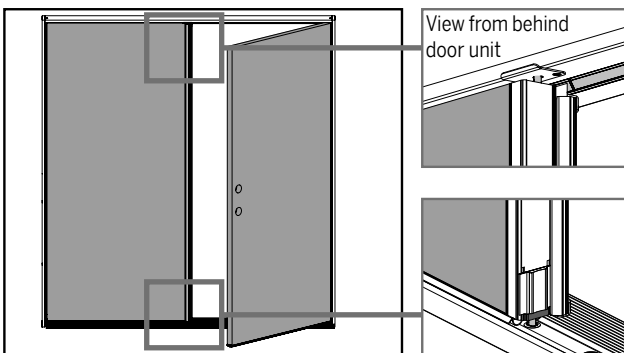

**a.** With the inactive door panel closed, engage both the upper and lower bolts to ensure they fit into the bolt receivers smoothly.

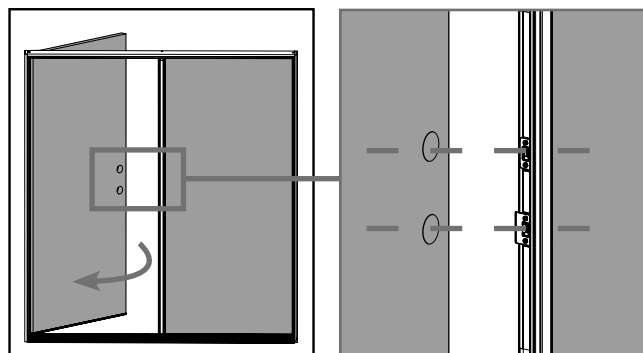

**b.** Close the active door panel and ensure the deadbolt and strike plates are aligned with the crossbore holes in the active door panel.

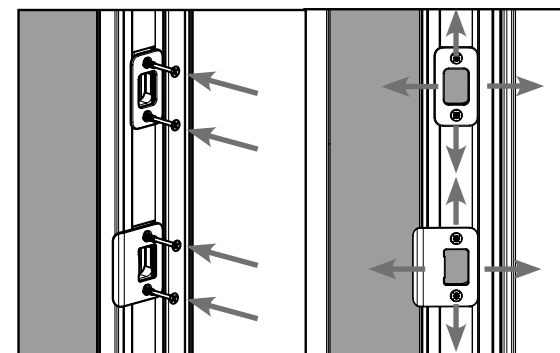

**c.** Replace the screws securing the strike and deadbolt plates with #8 x 3" screws. If the plates are misaligned, loosen the screws and adjust the location accordingly.